

KORA

Nádstavec KN4

945200340001 10



Upozornenie !

Pred montážou si prosím dôkladne preštudujte montážny návod.
Poškodenia vzniknuté nesprávnou montážou nebudú uznané v reklama nom konaní.

KN4

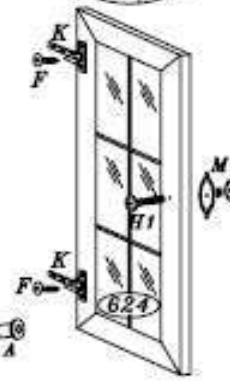
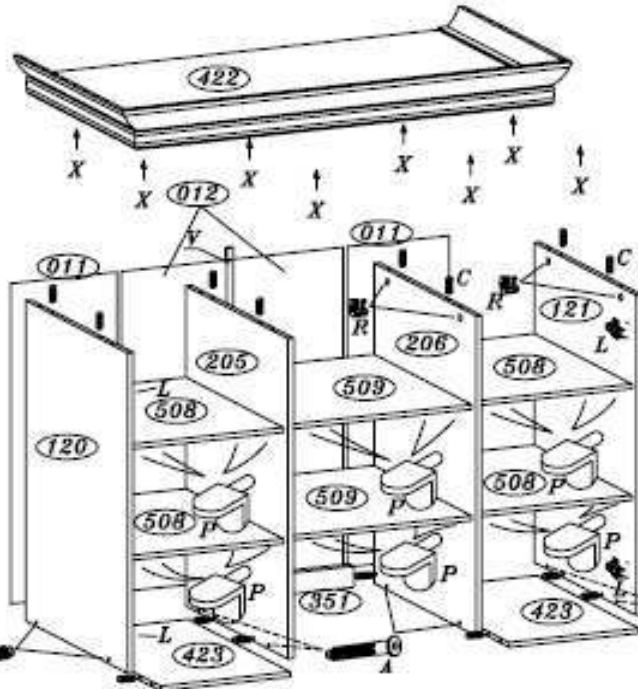
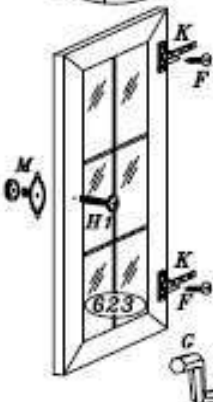
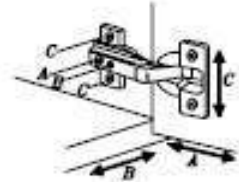
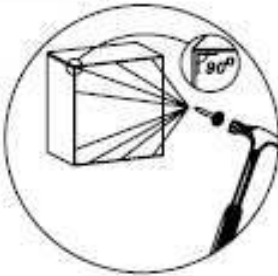
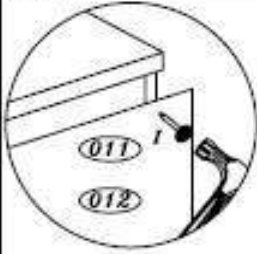
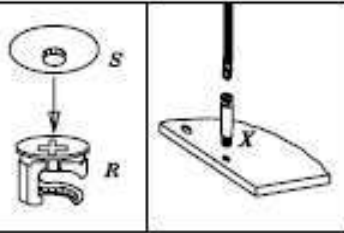

	Kód	Ks	Balík
1	422	1	3
2	423	2	1
3	120	1	1
4	121	1	1
5	205	1	1
6	206	1	1
7	011	2	3
8	012	2	3
9	508	4	1
10	509	2	1
11	351	1	3
12	623	1	2
13	624	1	2

M 4.0x37
2 ks H1

8 ks A	8 ks B	18 ks C	8 ks F	1 ks G	40 ks I	4 ks K	
2 ks M	1 ks O	24 ks P	8 ks R	8 ks S	1 ks V	4 ks L	8 ks X