

# 30 D CARGO BB

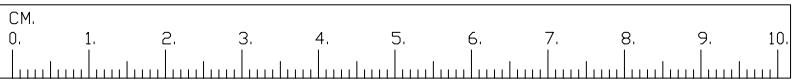

8	B	8	E1	8	A	1	O	1	S15	2	R2	10-15	P7	4	F2	4	R3	2	P4	2	E9
											Ø4, 0x30mm		Ø3, 0x20mm			Ø4, 0x35mm		Ø4, 0x45mm			

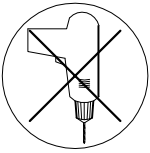
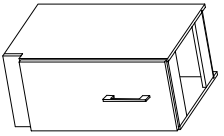
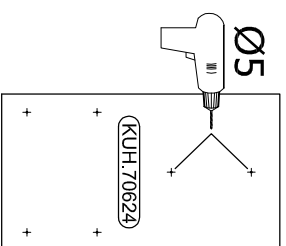
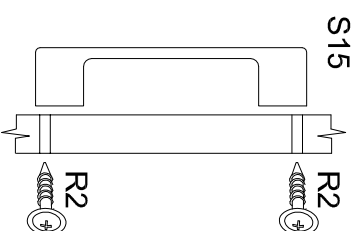
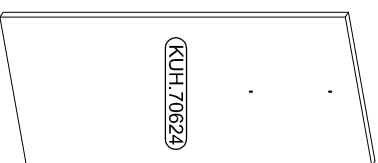
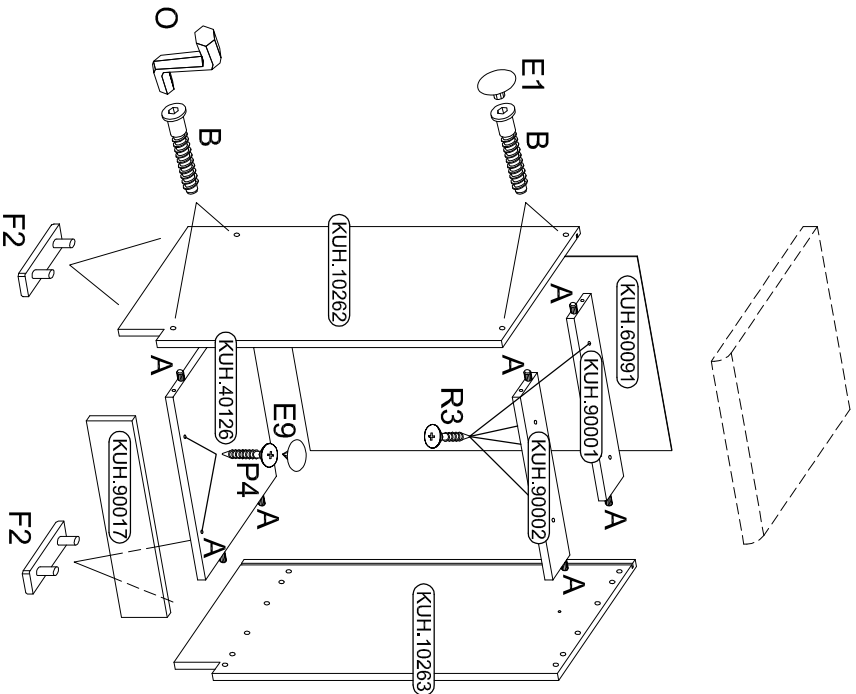
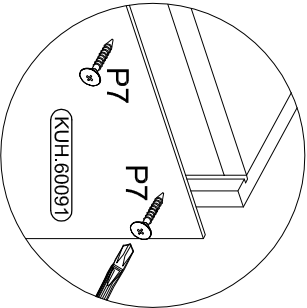
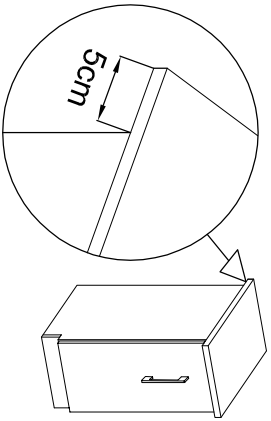

ISM-KUH-00758